

RKAT28 Prototype PCB Schematic - www.rkeducation.co.uk

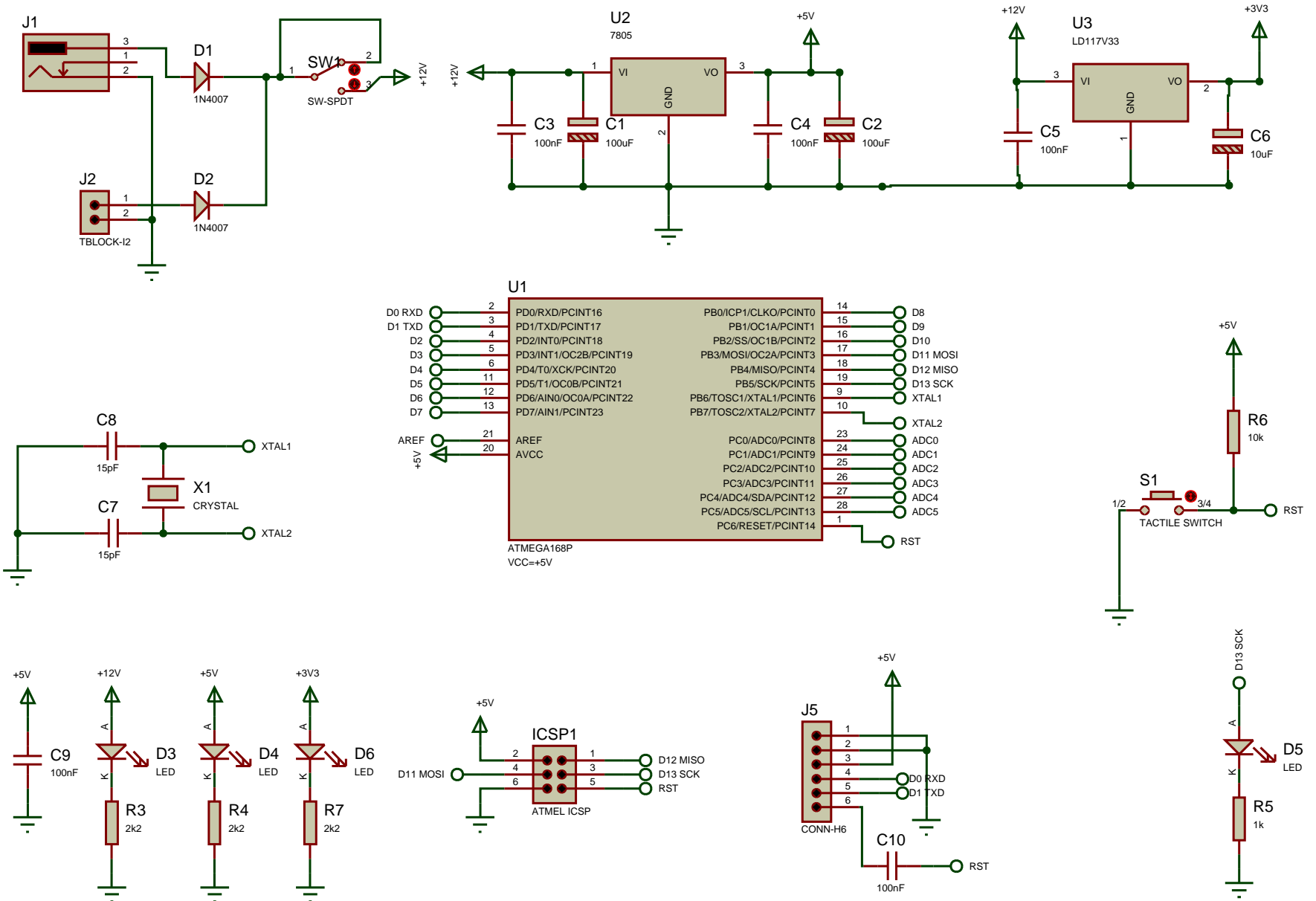

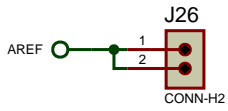

RKAT28 Prototype PCB Schematic Sheet 2 - www.rkeducation.co.uk

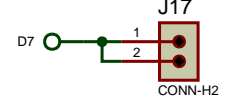
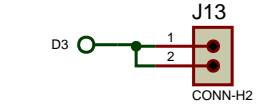
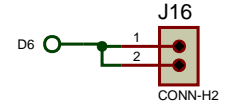
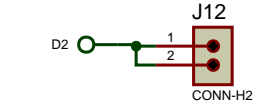
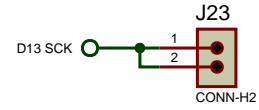
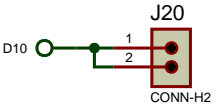
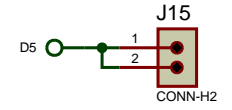
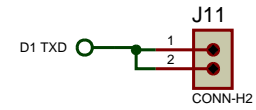
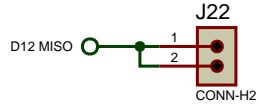
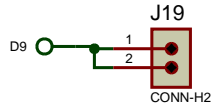
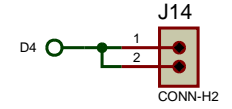
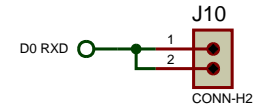
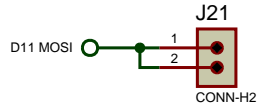
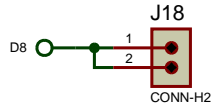