

RKP08c Project PCB Schematic - www.rkeducation.co.uk

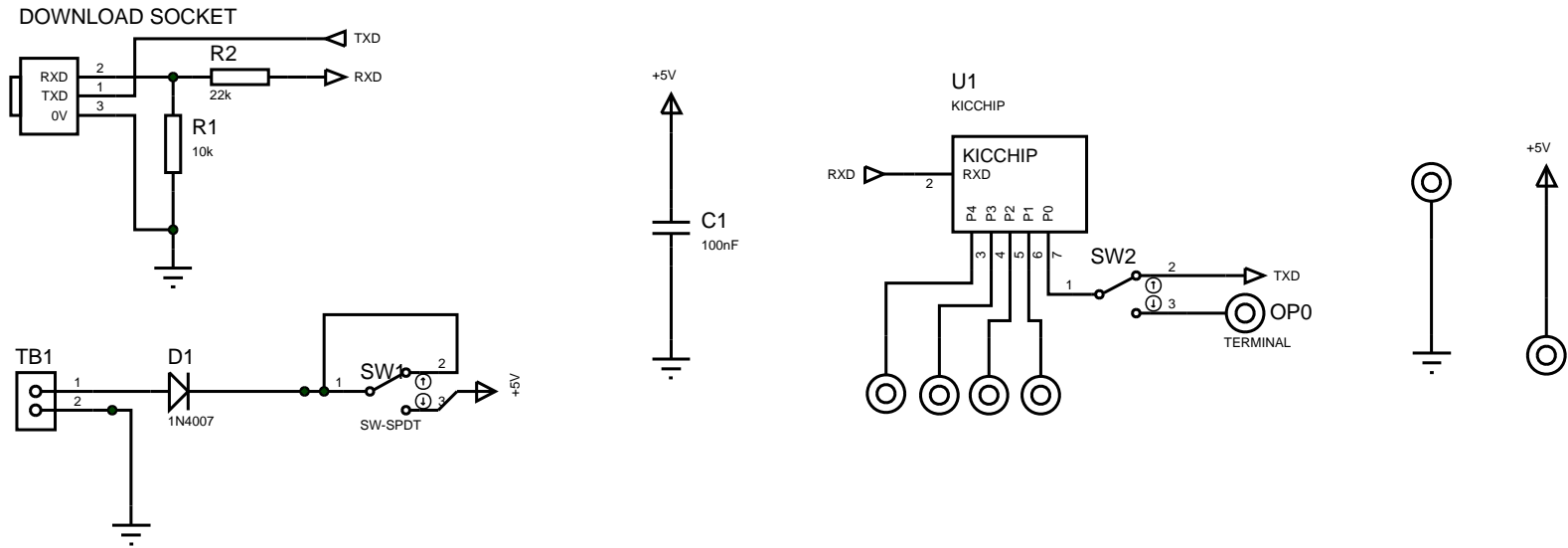

This PCB has been designed to be compatible with Genie and PICAXE